

### SKF SYNT 50 LTS参数

主要尺寸	d	50	mm	-
	A	70	mm	-
	H	131	mm	-
	H <sub>1</sub>	70	mm	-
	L	255	mm	-
基本额定载荷	C	104000	N	动载荷
	C <sub>0</sub>	108000	N	静载荷
疲劳载荷极限	P <sub>u</sub>	11800	N	-
极限转速	极限转速	4900	r/min	-
重量	重量	5800	g	-
型号	型号	SYNT 50 LTS	-	-
基本轴承型号	基本轴承型号	22210 E	-	-

### SKF SYNT 50 LTS图片

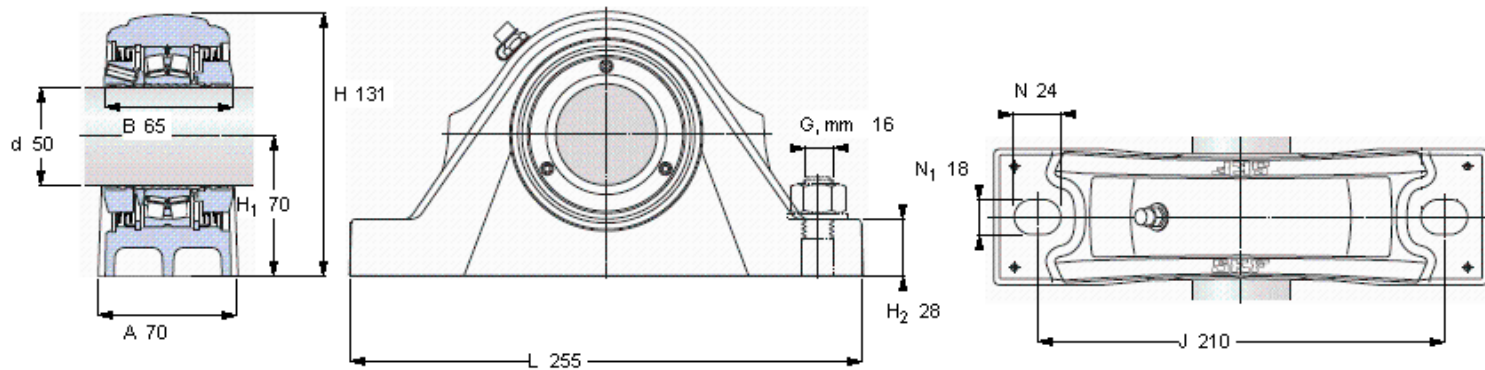

重新润滑脂量 [克]                    4  
允许轴向位移 [mm]  
(从中间位置)                         2,5

端盖  
ECY 210

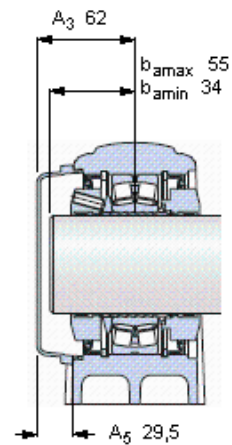

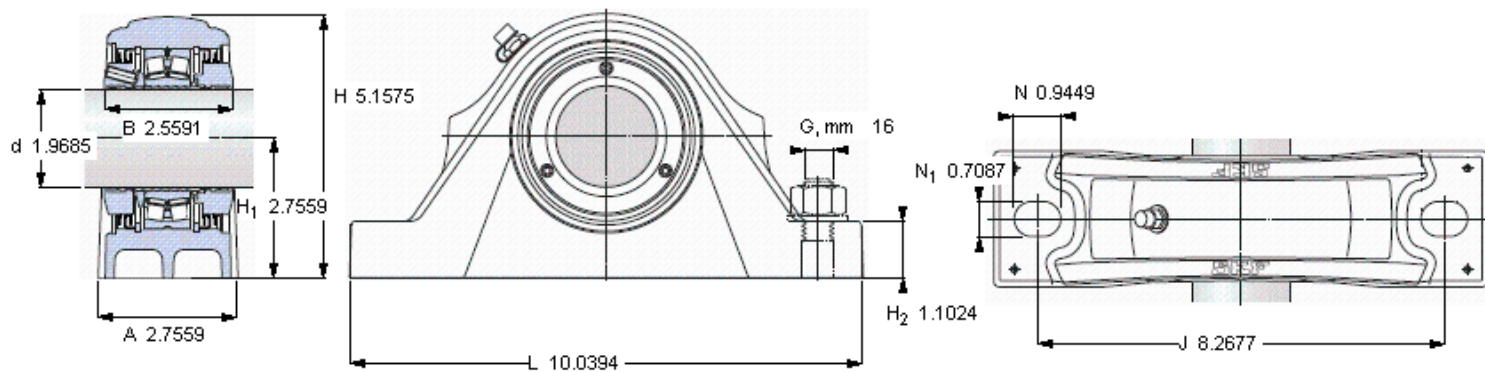

重新润滑脂量 [克]                    4  
 允许轴向位移 [mm]                2,5  
 (从中间位置)

端盖  
 ECY 210

