

SKF BEAS 017047-2RS参数

主要尺寸	d	17	mm	-
	D	47	mm	-
	H	25	mm	-
基本额定载荷	C	18000	N	动载荷
	C_0	31000	N	静载荷
疲劳载荷极限	P_u	1160	N	-
可达转速	Attainable speed	3800	r/min	-
重量	重量	220	g	-
型号	型号	BEAS 017047-2RS	-	-

SKF BEAS 017047-2RS图片

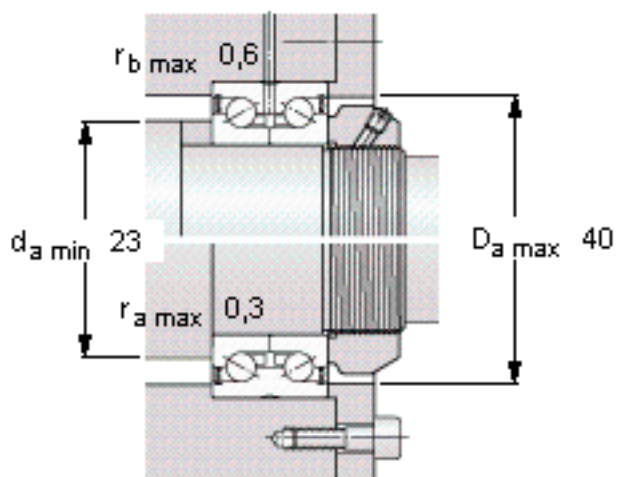
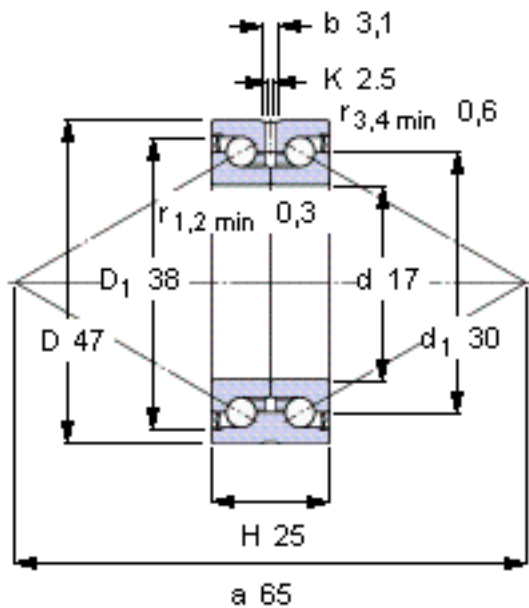

Preload¹⁾ [N]

720

Frictional moment¹⁾ [Nm]

(guideline value)

0,24

¹⁾ Values apply to unmounted bearings

Static stiffness¹⁾

(guideline values)

Axial [N/ μm]

420

Moment [Nm/mrad]

80

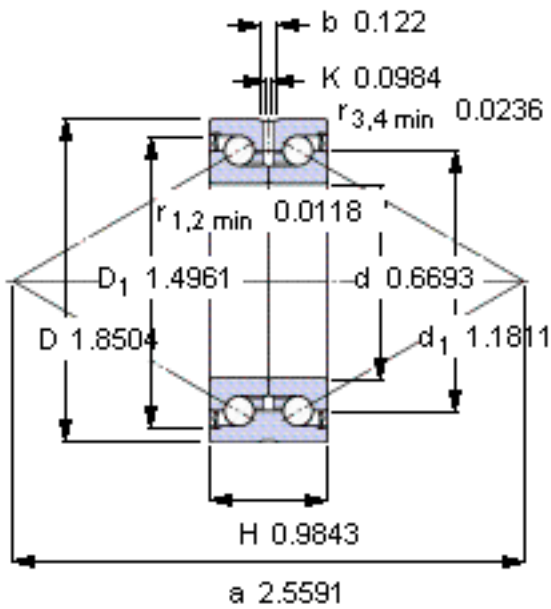

Preload¹⁾ [N]

720

Frictional moment¹⁾ [Nm]

(guideline value)

0,24

¹⁾ Values apply to unmounted bearings

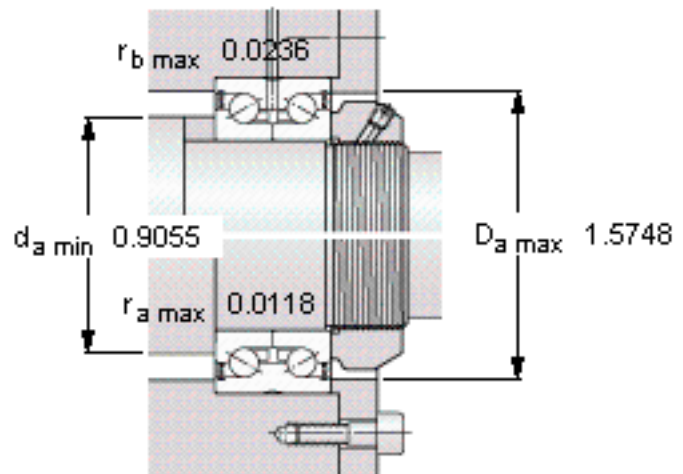

Static stiffness¹⁾

(guideline values)

Axial [N/ μm] 420

Moment [Nm/mrad] 80