

### SKF 53411参数

主要尺寸	d	55	mm	-
	D	120	mm	-
	H <sub>1</sub>	55	mm	-
基本额定载荷	C	178000	N	动载荷
	C <sub>0</sub>	390000	N	静载荷
疲劳载荷极限	P <sub>u</sub>	14300	N	-
最小载荷系数	A	0.79	-	-
额定转速	额定转度	1800	r/min	-
	极限转速	2400	r/min	-
重量	轴承+垫圈	3080	g	-
型号	轴承	53411	-	-
	座圈	U 411	-	-

### SKF 53411图片

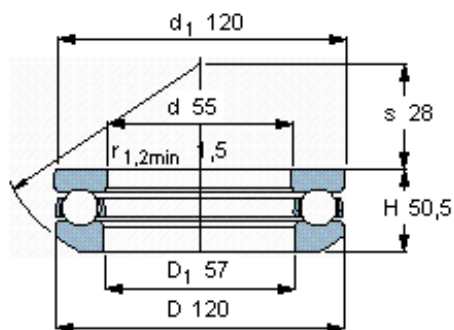

垫圈的球面曲率半径

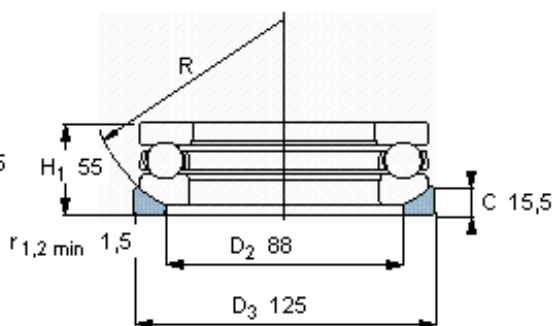

R 90

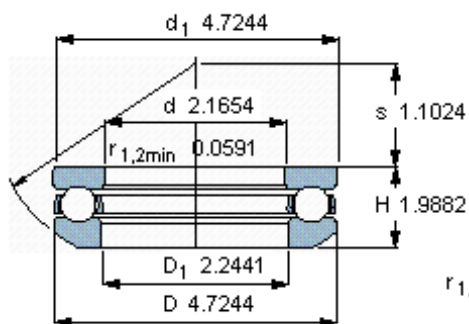
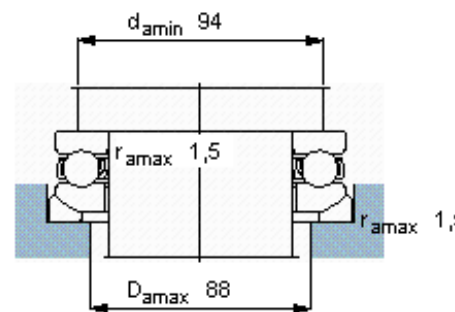

垫圈的球面曲率半径

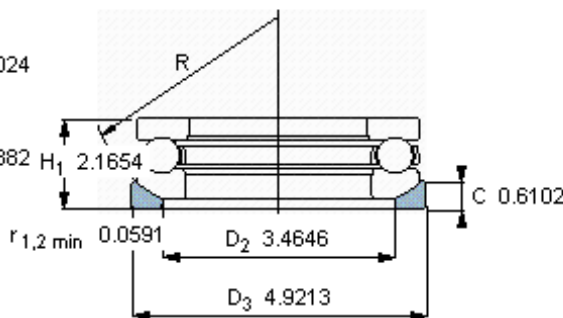

R 3.5433

