

SKF 71928 CD/HCP4AH1参数

主要尺寸	d	140	mm	-
	D	190	mm	-
	B	24	mm	-
基本额定载荷	C	95600	N	动载荷
	C_0	116000	N	静载荷
疲劳载荷极限	P_u	3900	N	-
可达转速	Grease	8000	r/min	-
	Oil-air	12000	r/min	-
重量	重量	1400	g	-
型号	型号	71928 CD/HCP4AH1	-	-

SKF 71928 CD/HCP4AH1图片

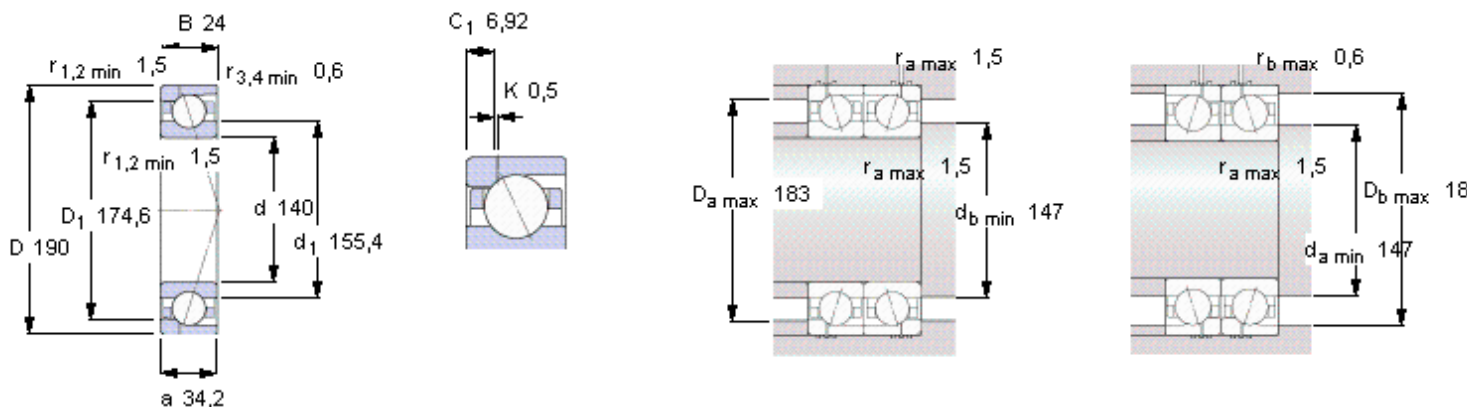

Ball diameter 15,875

Number of balls 29

未安装时的预载荷 [N]

背对背配置，面对面配置

预载荷等级

A	B	C	D
360	720	1440	2880

Static axial stiffness [N/μm]

(guideline value)

预载荷等级

A	B	C	D
162	223	317	467

Reference grease quantity [cm³]

G_{ref} 22

计算系数

for equivalent bearing load

f_0 16,6

for preload in mounted bearing sets

f 1,29

f_1 1

f_{2A} 1

f_{2B} 1,07

f_{2C} 1,12

f_{2D} 1,18

f_{HC} 1,04

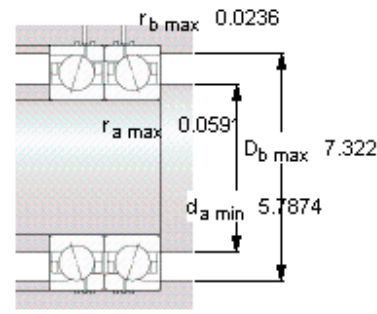
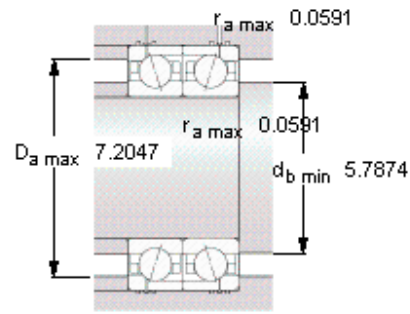
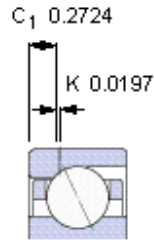
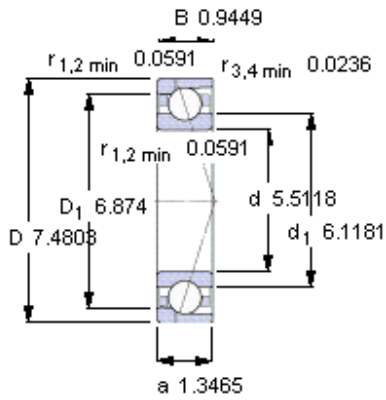

Ball diameter 15,875

Number of balls 29

未安装时的预载荷 [N]

背对背配置，面对面配置

预载荷等级

A	B	C	D
360	720	1440	2880

Static axial stiffness [N/μm]

(guideline value)

预载荷等级

A	B	C	D
162	223	317	467

Reference grease quantity [cm³]

G_{ref} 22

计算系数

for equivalent bearing load

f₀ 16,6

for preload in mounted bearing sets

f 1,29

f₁ 1

f_{2A} 1

f_{2B} 1,07

f_{2C} 1,12

f_{2D} 1,18

f_{HC} 1,04