

SKF 81136 M参数

主要尺寸	d	180	mm	-
	D	225	mm	-
	H	34	mm	-
基本额定载荷	C	270000	N	动载荷
	C_0	1270000	N	静载荷
疲劳载荷极限	P_u	110000	N	-
最小载荷系数	A	0.13	-	-
额定转速	额定转度	750	r/min	-
	极限转速	1500	r/min	-
重量	重量	3050	g	-
型号	完整轴承	81136 M	-	-
	滚子和保持架推力组件	K 81136 M	-	-

SKF 81136 M图片

完整轴承

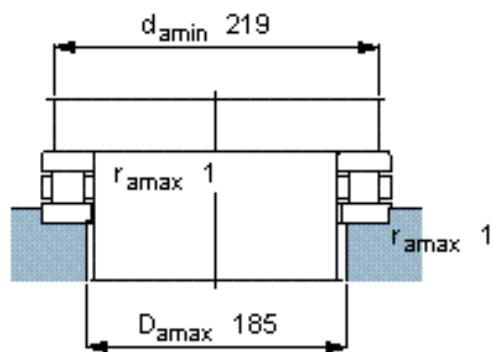
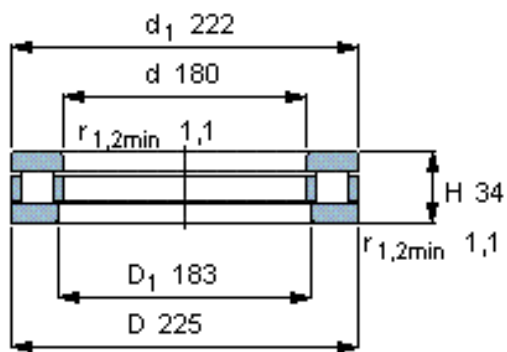

滚子和保持架推力组件

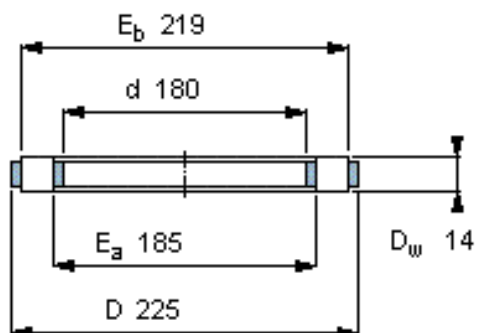

K 81136 M

质量 kg 0,90

适宜的部件

轴垫圈
WS 81136

轴承座垫圈
GS 81136

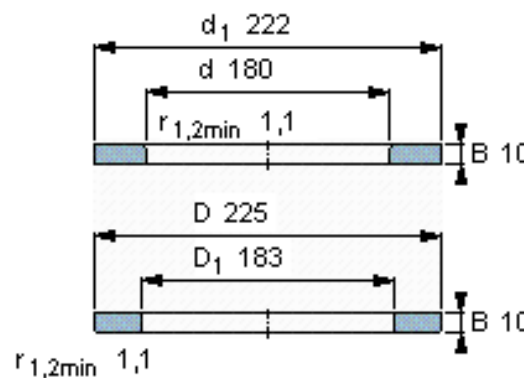

完整轴承

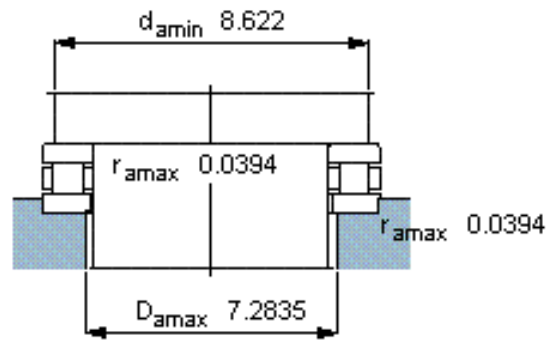
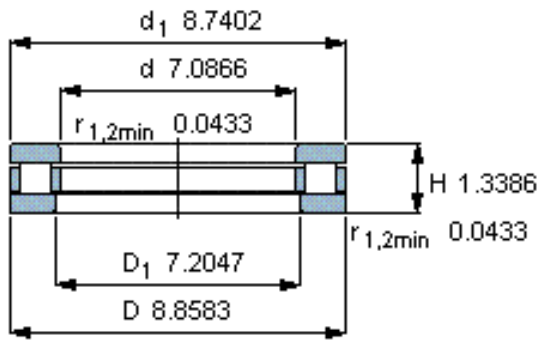

滚子和保持架推力组件

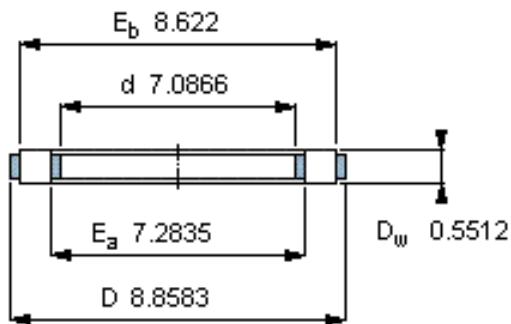

K 81136 M

质量 kg 0,90

适宜的部件

轴垫圈
WS 81136

轴承座垫圈
GS 81136

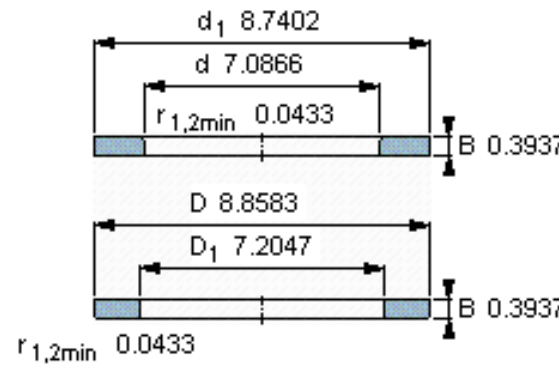

参考资料: <http://www.sozhou.com/p/24abb0a4.html>