

SKF S71911 CB/HCP4A参数

主要尺寸	d	55	mm	-
	D	80	mm	-
	B	13	mm	-
基本额定载荷	C	9950	N	动载荷
	C_0	8150	N	静载荷
疲劳载荷极限	P_u	345	N	-
可达转速	Grease	28000	r/min	-
	Oil-air	-	r/min	-
重量	重量	180	g	-
型号	型号	S71911 CB/HCP4A	-	-

SKF S71911 CB/HCP4A图片

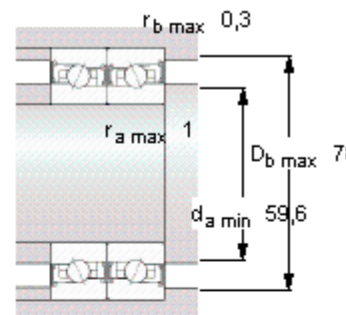
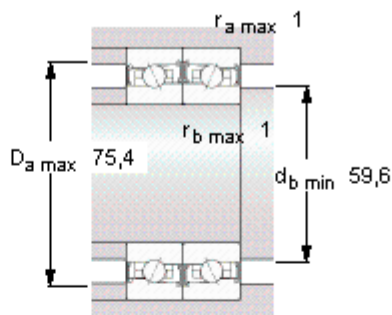
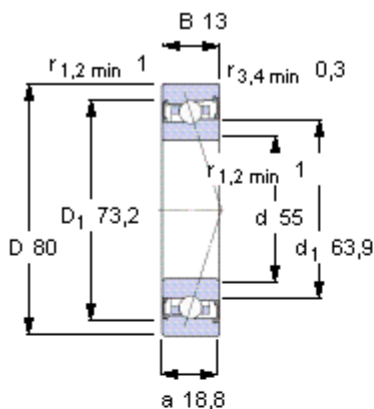

Ball diameter 5,556

Number of balls 28

未安装时的预载荷 [N]

背对背配置，面对面配置

预载荷等级

A	B	C	D
33	66	200	-

Static axial stiffness [N/μm]

(guideline value)

预载荷等级

A	B	C	D
38	50	80	-

Reference grease quantity [cm³]

G_{ref} -

计算系数

for equivalent bearing load

f_0 9,8

for preload in mounted bearing sets

f 1,09

f_1 1

f_{2A} 1

f_{2B} 1,03

f_{2C} 1,08

f_{2D} -

f_{HC} 1,01

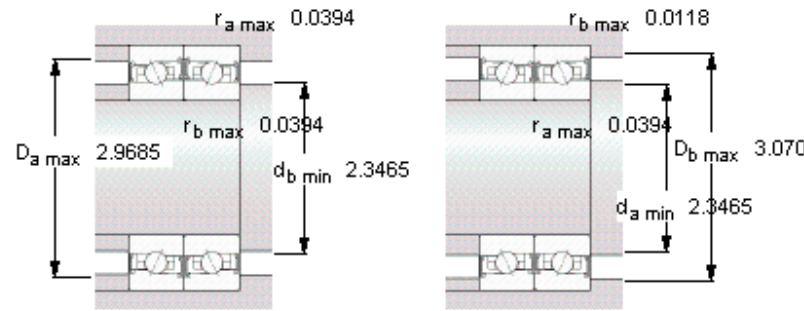
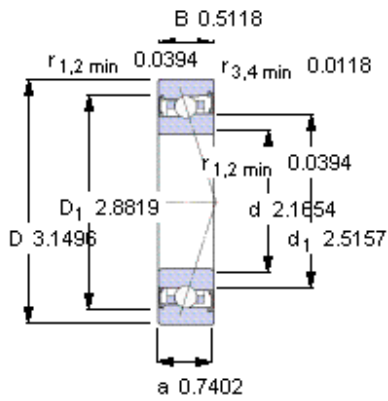

Ball diameter 5,556

Number of balls 28

未安装时的预载荷 [N]

背对背配置，面对面配置

预载荷等级

A	B	C	D
33	66	200	-

Static axial stiffness [N/μm]

(guideline value)

预载荷等级

A	B	C	D
38	50	80	-

Reference grease quantity [cm³]

G_{ref} -

计算系数

for equivalent bearing load

f₀ 9,8

for preload in mounted bearing sets

f 1,09

f₁ 1

f_{2A} 1

f_{2B} 1,03

f_{2C} 1,08

f_{2D} -

f_{HC} 1,01