

SKF 71912 CD/P4AL参数

主要尺寸	d	60	mm	-
	D	85	mm	-
	B	13	mm	-
基本额定载荷	C	19900	N	动载荷
	C_0	15300	N	静载荷
疲劳载荷极限	P_u	655	N	-
可达转速	Grease	15000	r/min	-
	Oil-air	24000	r/min	-
重量	重量	190	g	-
型号	型号	71912 CD/P4AL	-	-

SKF 71912 CD/P4AL图片

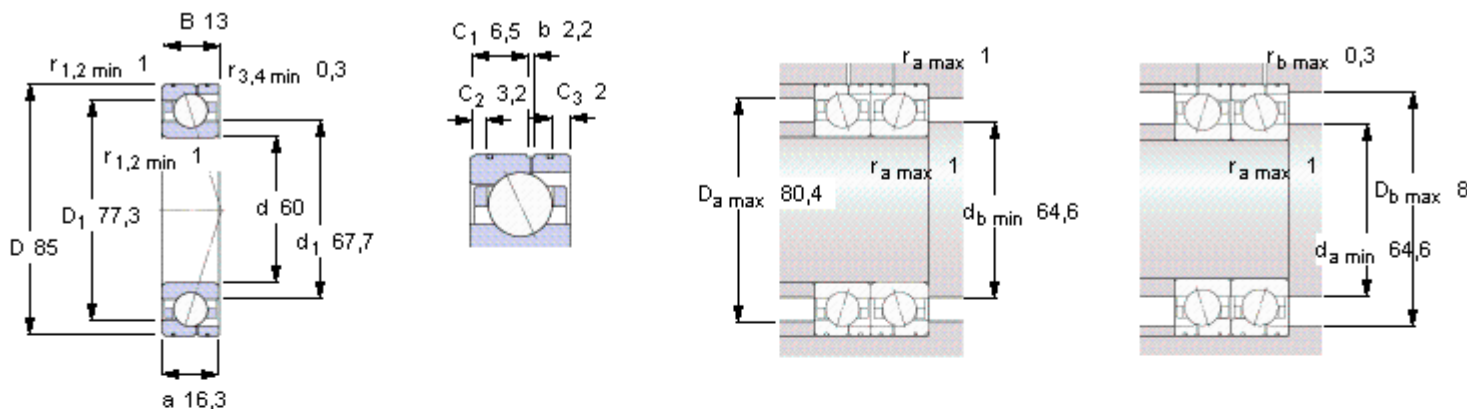

Ball diameter 7,938

Number of balls 24

未安装时的预载荷 [N]

背对背配置，面对面配置

预载荷等级

A	B	C	D
70	140	280	560

Static axial stiffness [N/ μm]

(guideline value)

预载荷等级

A	B	C	D
50	67	92	130

Reference grease quantity [cm³]

G_{ref} 2,7

计算系数

for equivalent bearing load

f_0 10,5

for preload in mounted bearing sets

f 1,17

f_1 1

f_{2A} 1

f_{2B} 1,04

f_{2C} 1,09

f_{2D} 1,15

f_{HC} 1

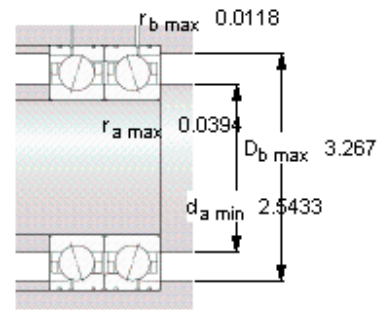
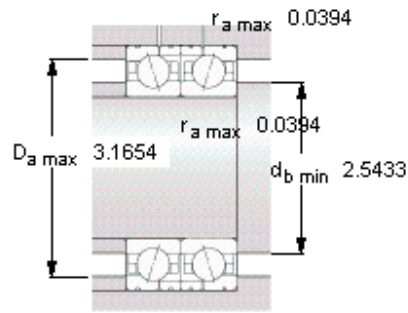
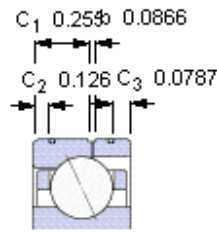
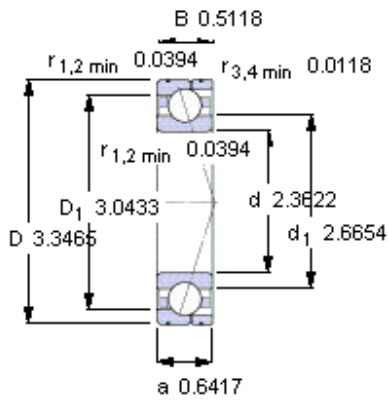

Ball diameter 7,938

Number of balls 24

未安装时的预载荷 [N]

背对背配置，面对面配置

预载荷等级

A	B	C	D
70	140	280	560

Static axial stiffness [N/μm]

(guideline value)

预载荷等级

A	B	C	D
50	67	92	130

Reference grease quantity [cm³]

G_{ref} 2,7

计算系数

for equivalent bearing load

f₀ 10,5

for preload in mounted bearing sets

f 1,17

f₁ 1

f_{2A} 1

f_{2B} 1,04

f_{2C} 1,09

f_{2D} 1,15

f_{HC} 1