

SKF 811/600 M参数

主要尺寸	d	600	mm	-
	D	710	mm	-
	H	85	mm	-
基本额定载荷	C	1800000	N	动载荷
	C_0	11600000	N	静载荷
疲劳载荷极限	P_u	720000	N	-
最小载荷系数	A	11	-	-
额定转速	额定转度	240	r/min	-
	极限转速	500	r/min	-
重量	重量	62000	g	-
型号	完整轴承	811/600 M	-	-
	滚子和保持架推力组件	K 811/600 M	-	-

SKF 811/600 M图片

完整轴承

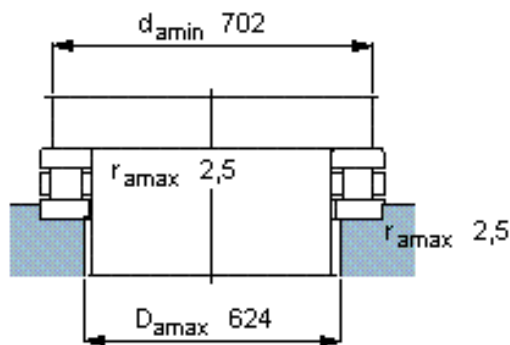
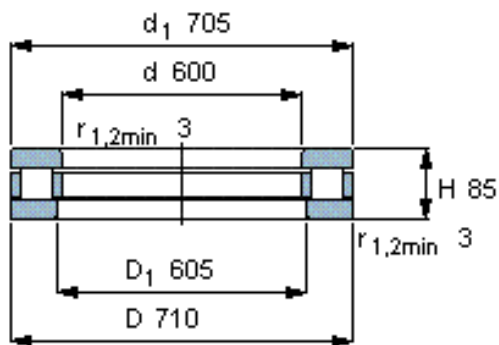

滚子和保持架推力组件

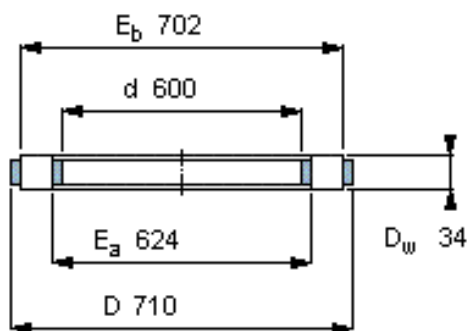

K 811/600 M

质量 kg 16,7

适宜的部件

轴垫圈
WS 811/600

轴承座垫圈
GS 811/600

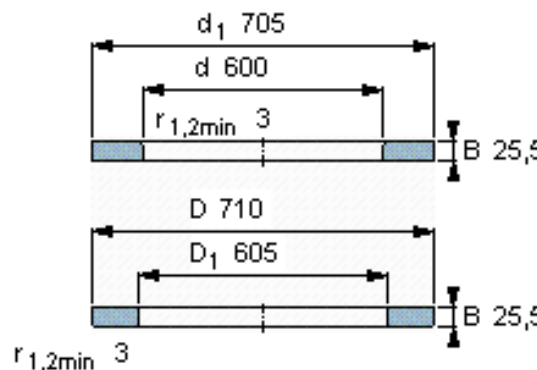

完整轴承

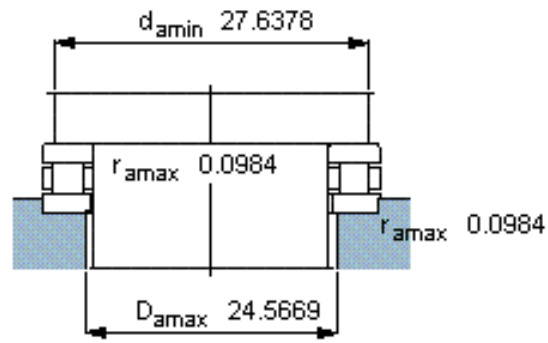
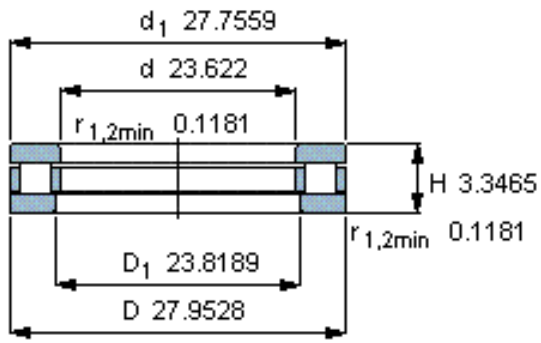

滚子和保持架推力组件

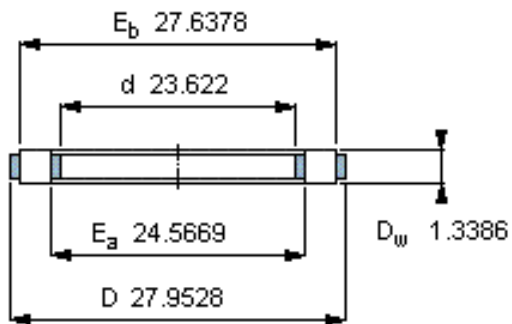

K 811/600 M

质量 kg 16,7

适宜的部件

轴垫圈
WS 811/600

轴承座垫圈
GS 811/600

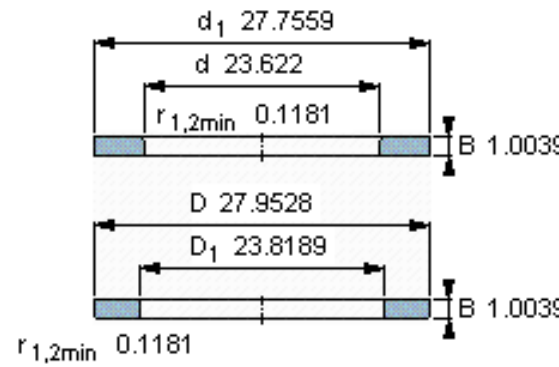

参考资料: <http://www.sozhou.com/p/5684df5a.html>