

### SKF 81148 M参数

主要尺寸	d	240	mm	-
	D	300	mm	-
	H	45	mm	-
基本额定载荷	C	475000	N	动载荷
	$C_0$	2450000	N	静载荷
疲劳载荷极限	$P_u$	196000	N	-
最小载荷系数	A	0.48	-	-
额定转速	额定转度	560	r/min	-
	极限转速	1100	r/min	-
重量	重量	7250	g	-
型号	完整轴承	81148 M	-	-
	滚子和保持架推力组件	K 81148 M	-	-

### SKF 81148 M图片

#### 完整轴承

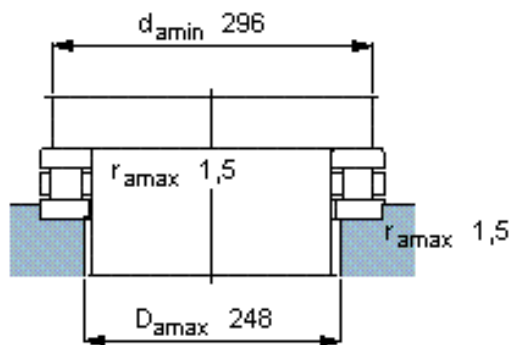
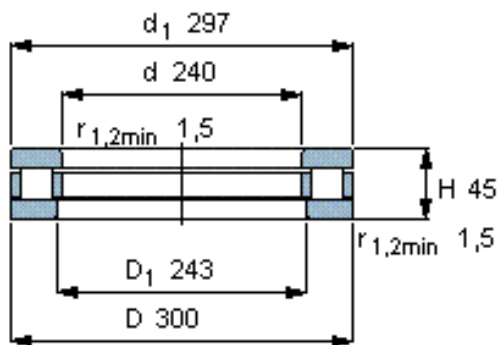

#### 滚子和保持架推力组件

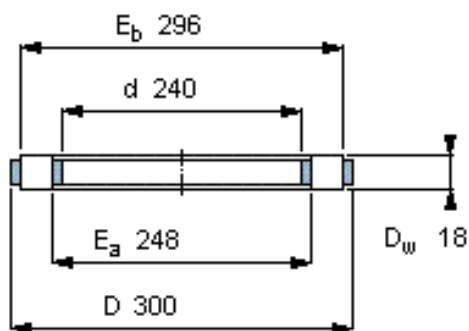

#### 适宜的部件

轴垫圈  
WS 81148

轴承座垫圈  
GS 81148

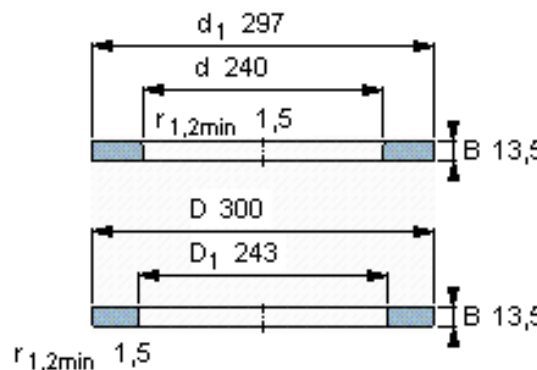

K 81148 M

质量 kg 2,04

**完整轴承**

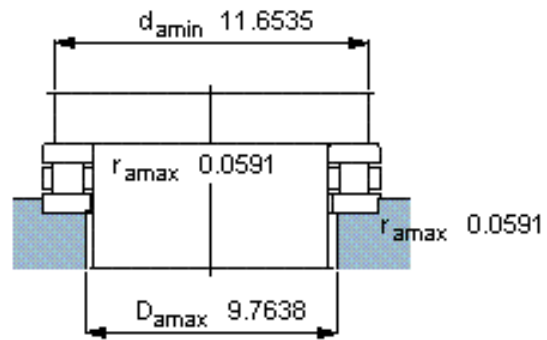
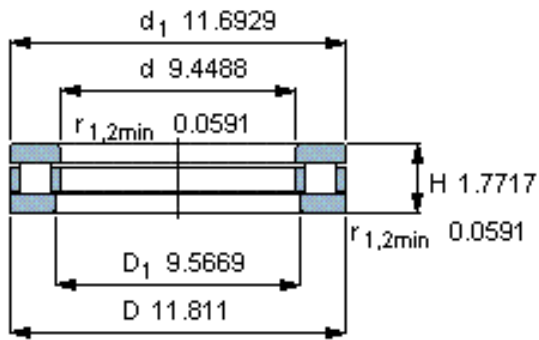

**滚子和保持架推力组件**

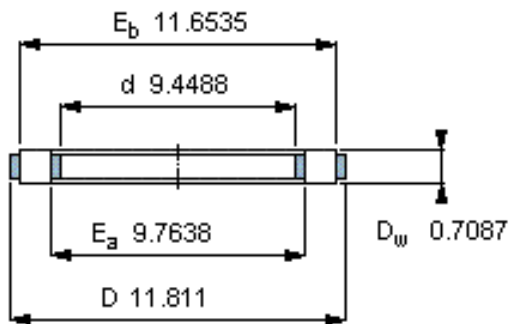

K 81148 M

质量 kg 2,04

**适宜的部件**

轴垫圈  
WS 81148

轴承座垫圈  
GS 81148

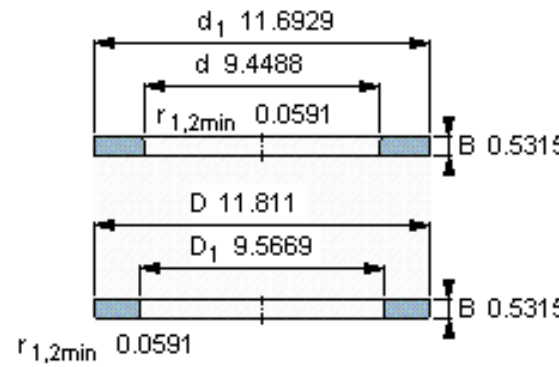

参考资料: <http://www.sozhou.com/p/655b6dd2.html>