

TIMKEN 150RU91参数

轴承型号	Part Number	150RU91		-
	Subtype	NU		-
尺寸	d	150	mm	内径
	D	235.001	mm	外径
	B	66.7004	mm	宽度
额定载荷	C1	653889	N	一百万转动态径向载荷
	C0	889644	N	静态额定载荷
几何结构系数	Cg	0.1693		几何系数
极限转速	oil	3200		润滑油
	grease	2500		润滑脂
尺寸	R	2.032	mm	最大轴肩倒角半径
	da	165.1	mm	轴肩直径
	r	2.032	mm	最大轴承座挡肩圆角半径
	Da	219.964	mm	轴承座挡肩直径
重量	Assembly Weight	11113.01	g	-

TIMKEN 150RU91图片

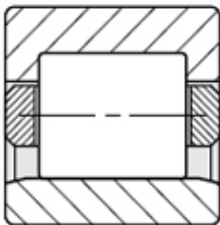
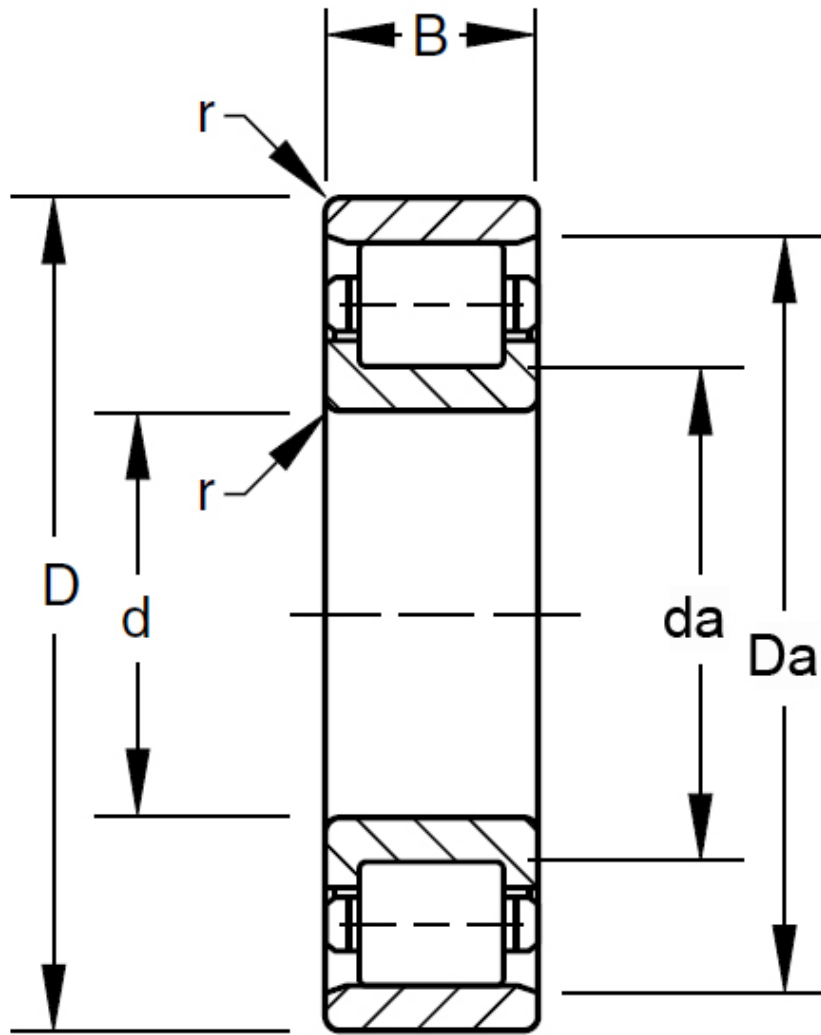

RU
RIU

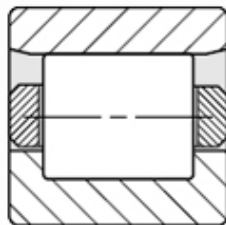

RN
RIN

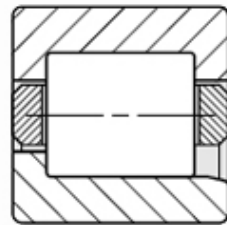

RJ
RIJ

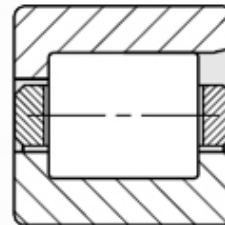

RF
RIF

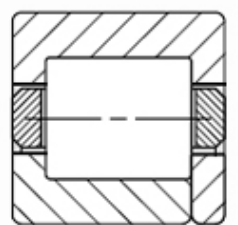

RT
RIT

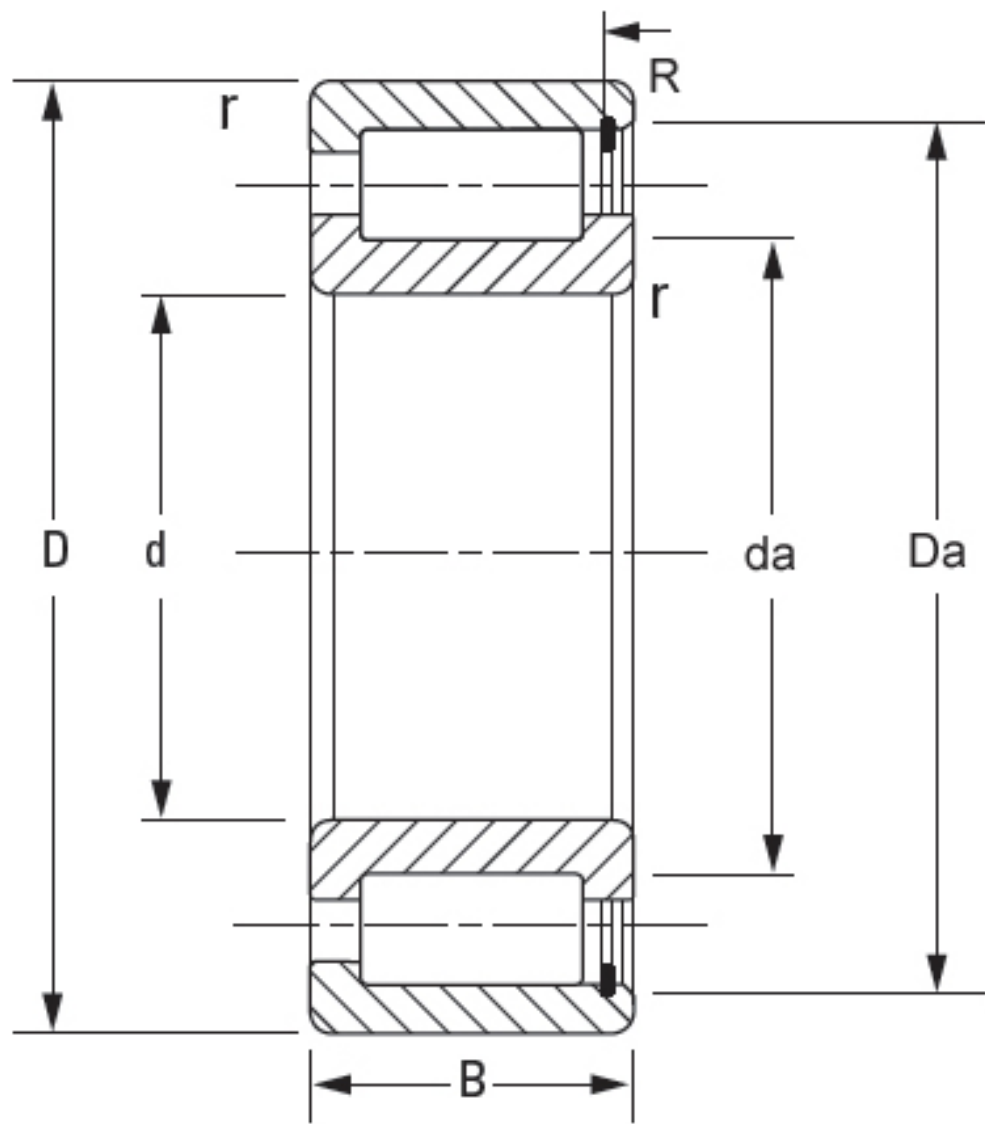

NCF