

SKF SYNT 45 FW参数

主要尺寸	d	45	mm	-
	A	60	mm	-
	H	118	mm	-
	H ₁	60	mm	-
	L	205	mm	-
基本额定载荷	C	102000	N	动载荷
	C ₀	98000	N	静载荷
疲劳载荷极限	P _u	10800	N	-
极限转速	极限转速	3500	r/min	-
重量	重量	4000	g	-
型号	型号	SYNT 45 FW	-	-
基本轴承型号	基本轴承型号	22209 E	-	-

SKF SYNT 45 FW图片

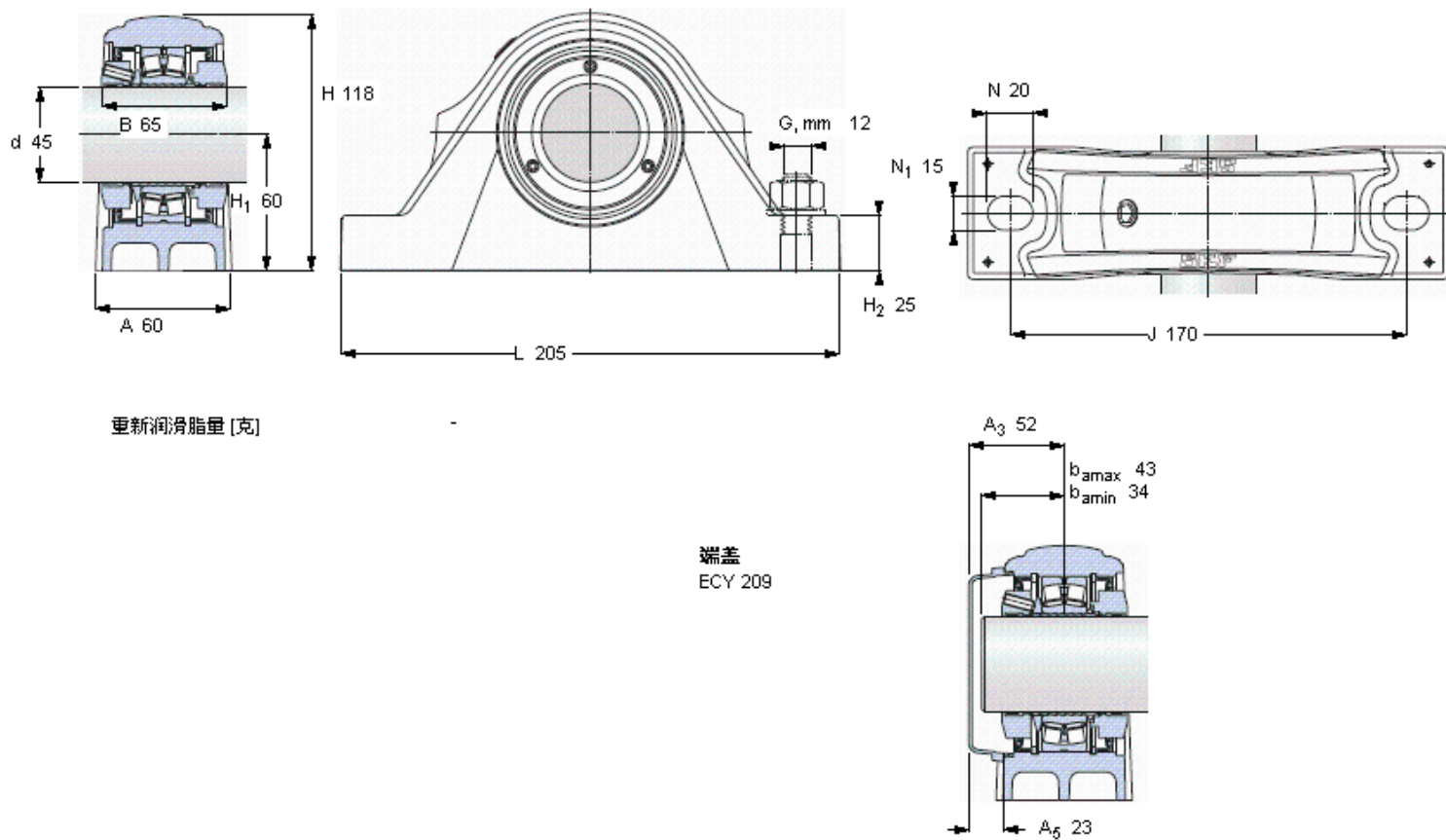

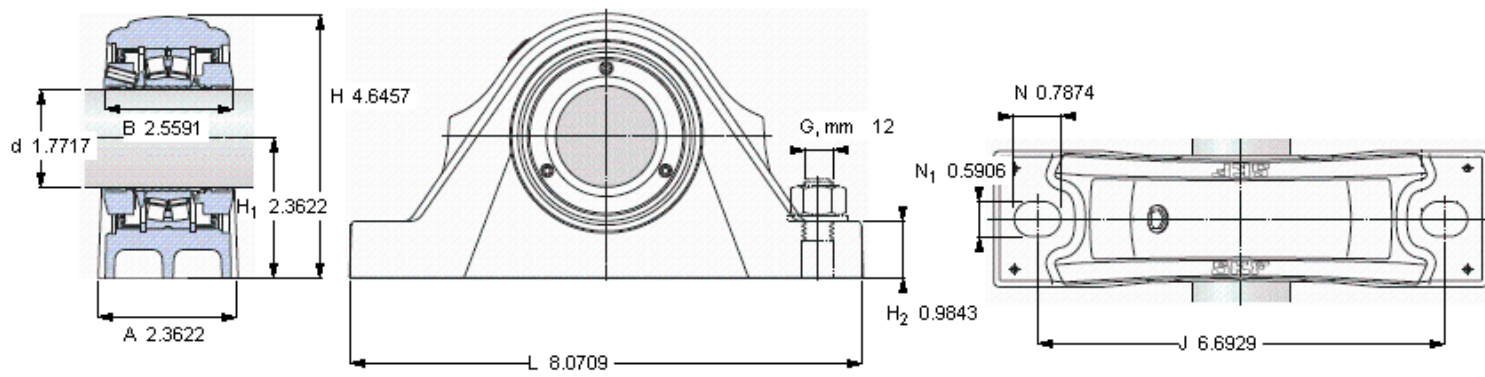

重新润滑脂量 [克]

-

端盖
ECY 209

