

SKF 7022 CE/HCP4AH1参数

主要尺寸	d	110	mm	-
	D	170	mm	-
	B	28	mm	-
基本额定载荷	C	47500	N	动载荷
	C_0	45000	N	静载荷
疲劳载荷极限	P_u	1600	N	-
可达转速	Grease	12700	r/min	-
	Oil-air	20000	r/min	-
重量	重量	1950	g	-
型号	型号	7022 CE/HCP4AH1	-	-

SKF 7022 CE/HCP4AH1图片

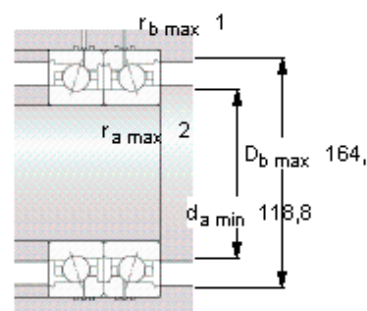
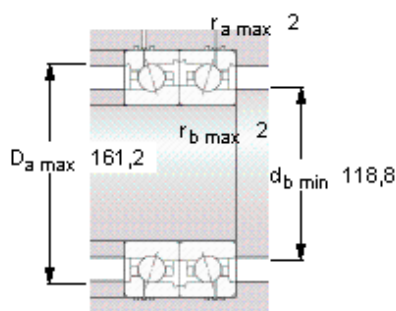
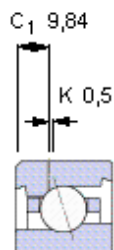
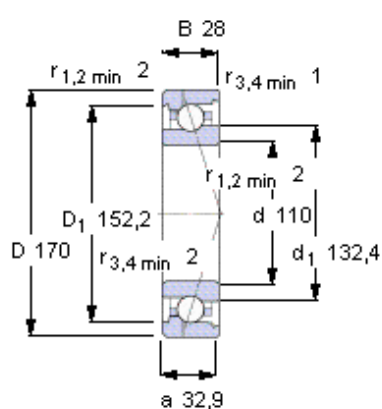

Ball diameter 12,7

Number of balls 30

未安装时的预载荷 [N]

背对背配置，面对面配置

预载荷等级

A	B	C	D
250	760	1520	-

Static axial stiffness [N/μm]

(guideline value)

预载荷等级

A	B	C	D
104	165	226	-

Reference grease quantity [cm³]

G_{ref} 23

计算系数

for equivalent bearing load

f_0 9,6

for preload in mounted bearing sets

f 1,1

f_1 1

f_{2A} 1

f_{2B} 1,03

f_{2C} 1,05

f_{2D} -

f_{HC} 1,01

参考资料: <http://www.sozhou.com/p/df0af1e4.html>

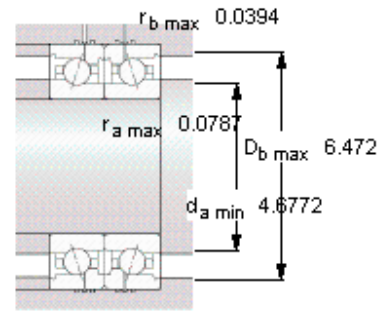
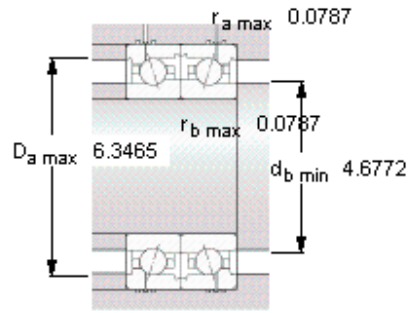
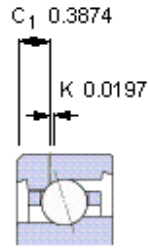
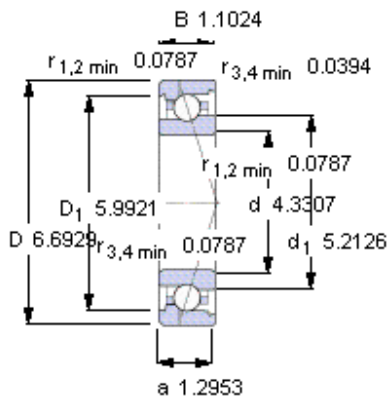

Ball diameter 12,7
Number of balls 30

未安装时的预载荷 [N]

背对背配置，面对面配置

预载荷等级

A	B	C	D
250	760	1520	-

Static axial stiffness [N/μm]

(guideline value)

预载荷等级

A	B	C	D
104	165	226	-

Reference grease quantity [cm³]

G_{ref} 23

计算系数

for equivalent bearing load

f₀ 9,6

for preload in mounted bearing sets

f 1,1

f₁ 1

f_{2A} 1

f_{2B} 1,03

f_{2C} 1,05

f_{2D} -

f_{HC} 1,01